



Prestigic Fence Products

YOUR FENCE PROFESSIONALS

"Exceptional Service is our signature."

Residential, Commercial & Industrial **Aluminum** Fencing Solutions



866-697-8237



info.pvcfp.com



www.pvcfp.com

ALUMINUM FENCE FEATURES & BENEFITS

At Prestigic Fence Products, we understand that every home deserves a tailored design. That's why we offer solutions that complement any home's aesthetic while meeting all functional requirements.

Residential Grade

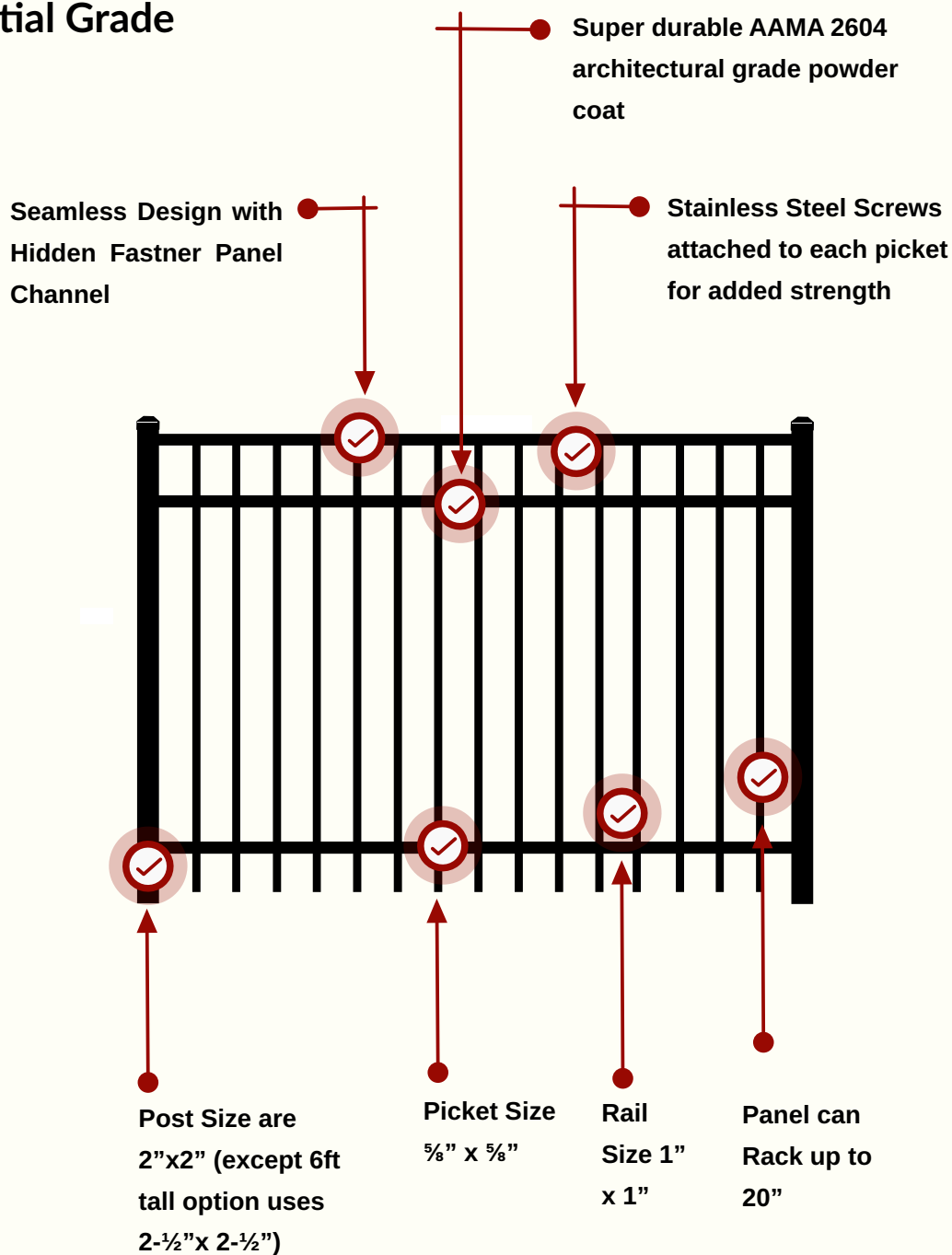



Aluminum Fence Picket and Rail Information

When it comes to aluminum fence picket and rail, you have a variety of options for both style and height. Additionally, you can choose between standard spacing or various picket options, such as doggie picket, double picket that stops at the middle rail, or full double picket.

RESIDENTIAL SECTION STANDARD PANEL HEIGHTS

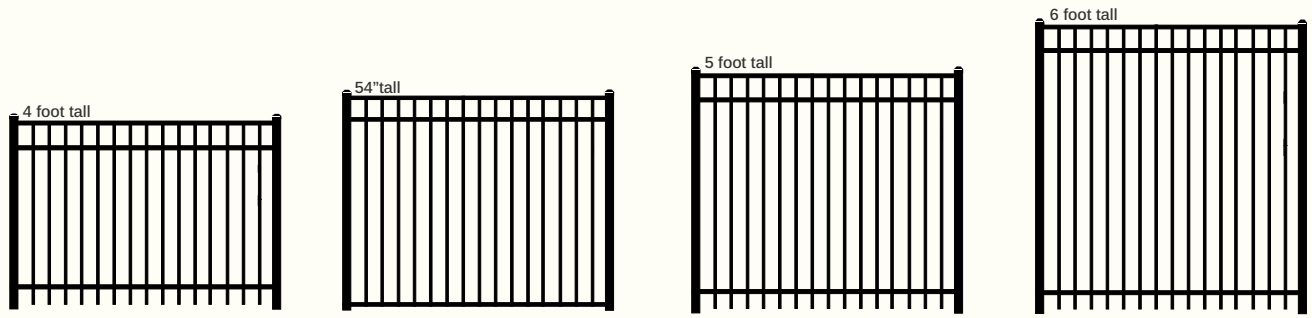

SECTION WIDTH PANEL RACKING POST/RAIL CONNECTION

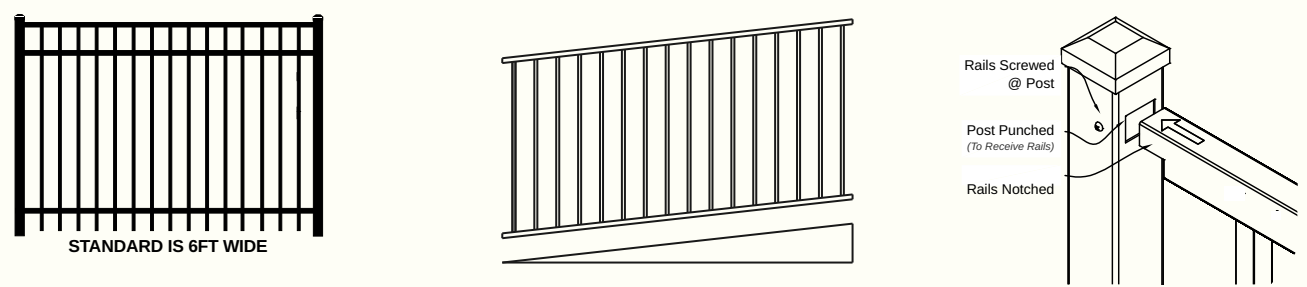

SECTION RAIL - 2, 3 OR 4 FENCE PANEL PICKET OPTIONS PICKET FASTENER

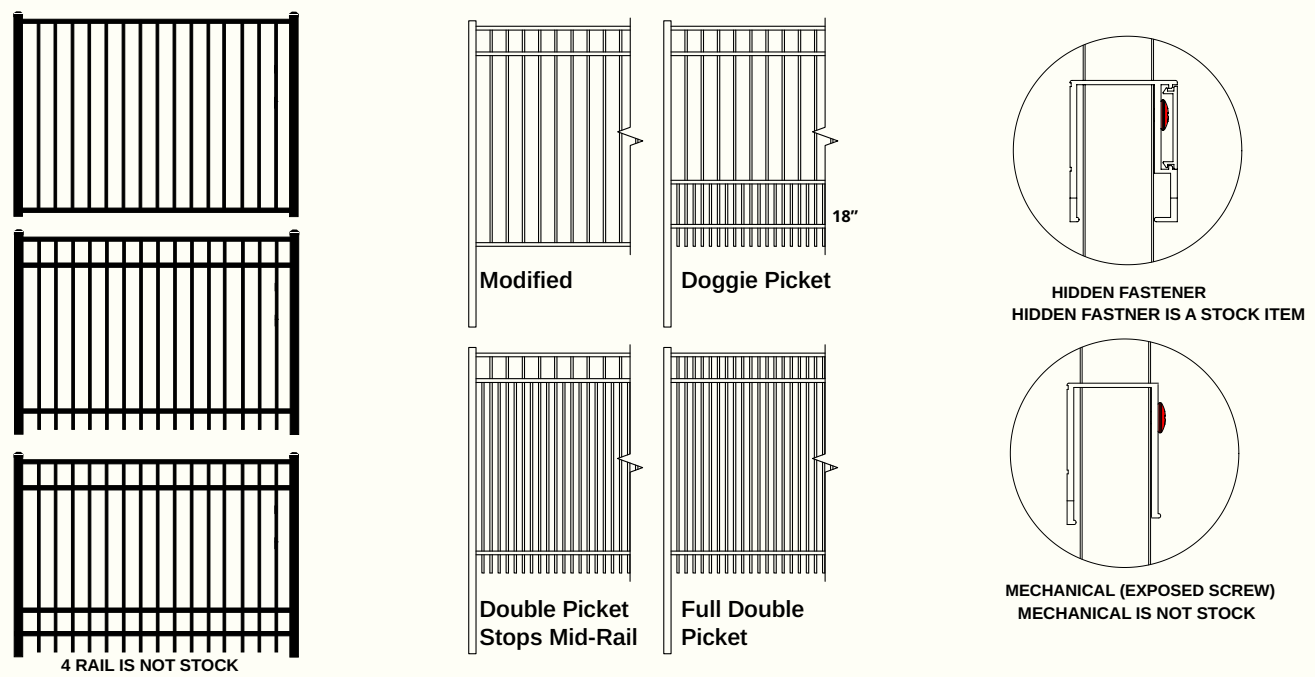



Residential Grade Aluminum Fence

Maverick Ultra residential grade aluminum fencing offers a classic look of a narrow picket. This grade of aluminum fencing offers a great look and durability for residential pools, backyards and as a decorative perimeter fence. Maverick Ultra aluminum fencing is finished with super durable AAMA 2604 architectural grade powder coat and is warranted against rust, peel, chip, or crack, as long as you own your fence.



RESIDENTIAL ALUMINUM STYLES

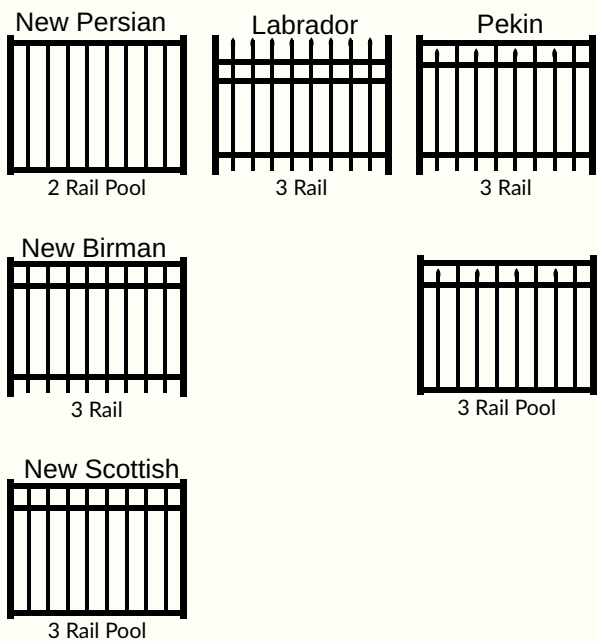

POSTS

- 2" x 2" .062 wall
- 2" x 2" .080 wall
- 2" x 2" .125 wall
- 2 -1/2" x 2-1/2" .080 wall
- 2 -1/2" x 2-1/2" .125 wall

RAILS

- 1"x1" Rail .080 wall

PICKET SIZE

- 5/8" x 5/8" .045 wall

PICKET SPACING

3-13/16"

PANEL WIDTHS

6' (72") wide only

PANEL OPTIONS

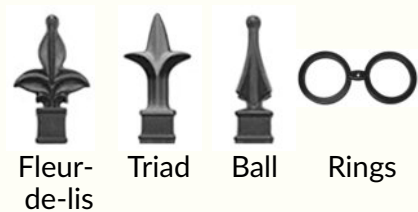

PANEL CHANNEL

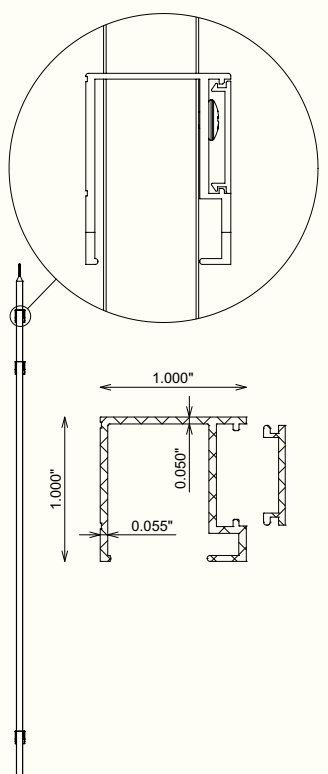



Commercial Grade Aluminum Fence

Maverick Ultra Plus aluminum fencing is offered in commercial, high-end residential, and perimeter security fencing options. Maverick Ultra Plus works great for commercial pools, estate fencing, golf courses and cemeteries. Maverick Ultra Plus aluminum fencing is finished with super durable AAMA 2604 architectural grade powder coat and is warranted against rust, peel, chip, or crack, as long as you own your fence.



COMMERCIAL ALUMINUM STYLES

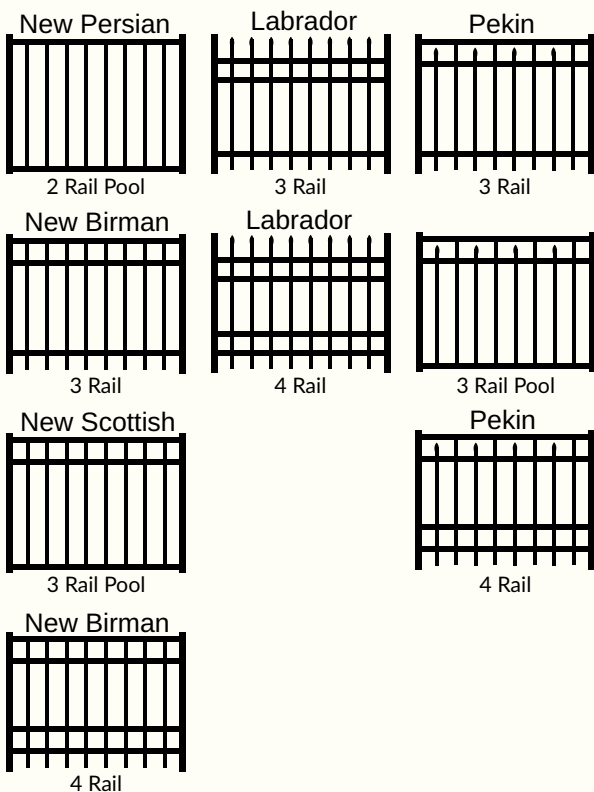

POSTS

- 2" x 2"
- 2" x 2"
- 2" x 2"
- 2-1/2" x 2-1/2"
- 2-1/2" x 2-1/2"
- 3" x 3"

RAILS

- 1-1/2" x 1-1/8"

PICKET SIZE

- 3/4" x 3/4"

PICKET SPACING

- 3-13/16"

PANEL WIDTHS

- 6' (72") and 8' (96")

PANEL OPTIONS

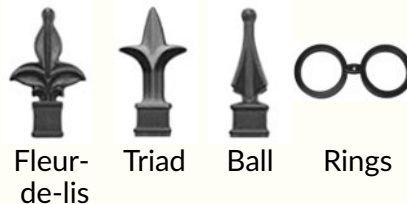

- .062 wall
- .080 wall
- .125 wall
- .080 wall
- .125 wall
- .125 wall

- .080 wall

- .050 wall

PANEL CHANNEL

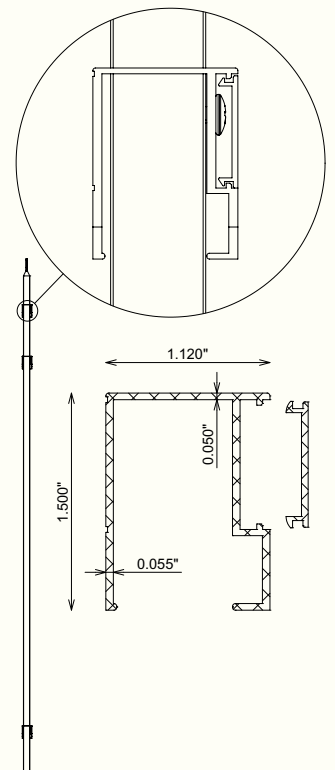

Industrial Grade Aluminum Fence

Maverick Ultra II industrial grade aluminum fencing is Iron World's strongest, most durable aluminum fence offered. With Iron World's "Heavy" horizontal rails and 1" square pickets this fence will stand the test of time. Maverick Ultra II is the choice for large residential properties, public facilities, storage & commercial properties and security fencing for any commercial / Industrial properties. Maverick Ultra II aluminum fencing is finished with super durable AAMA 2604 architectural grade powder coat and is warranted against rust, peel, chip, or crack, as long as you own your fence.



INDUSTRIAL ALUMINUM STYLES

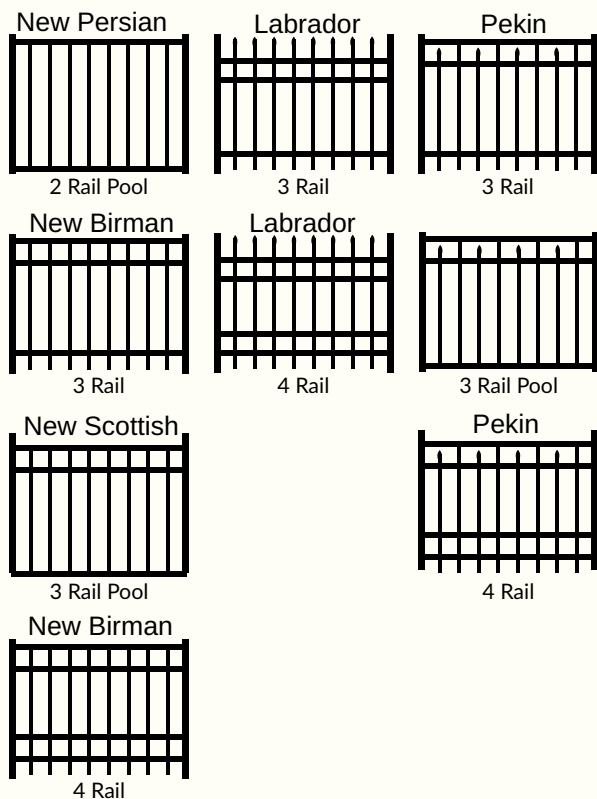

POSTS

- 2-1/2" x 2-1/2" .080 wall
- 2-1/2" x 2-1/2" .125 wall
- 3" x 3" .125 wall
- 4" x 4" (blank) .125 wall

RAILS

- 1-5/8" x 1-5/8" .100 wall

PICKET SIZE

- 1" x 1" .062 wall

PICKET SPACING

- 3-13/16"

PANEL WIDTHS

- 6' (72") and 8' (96")

PANEL OPTIONS

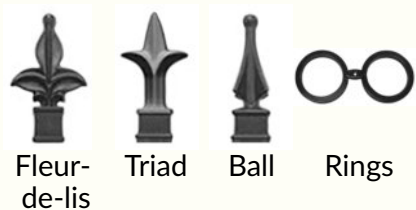

PANEL CHANNEL

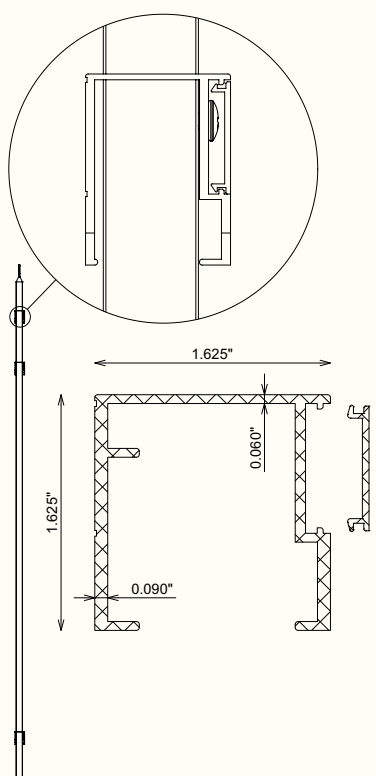



ALUMINUM SWING GATES

Iron World™ offers a complete line of swing gates (walk and double drive) that offer privacy and security in a multitude of styles. Designed to complement any setting and enhance both commercial and residential properties, Iron World™ swing gates are custom made to precisely fit your opening. All aluminum swing gates can be made using our residential, commercial, or industrial materials. Swing gates can range in size from 3 foot single gates to 40 foot double gates. We offer all styles with rings, finials, and arches.

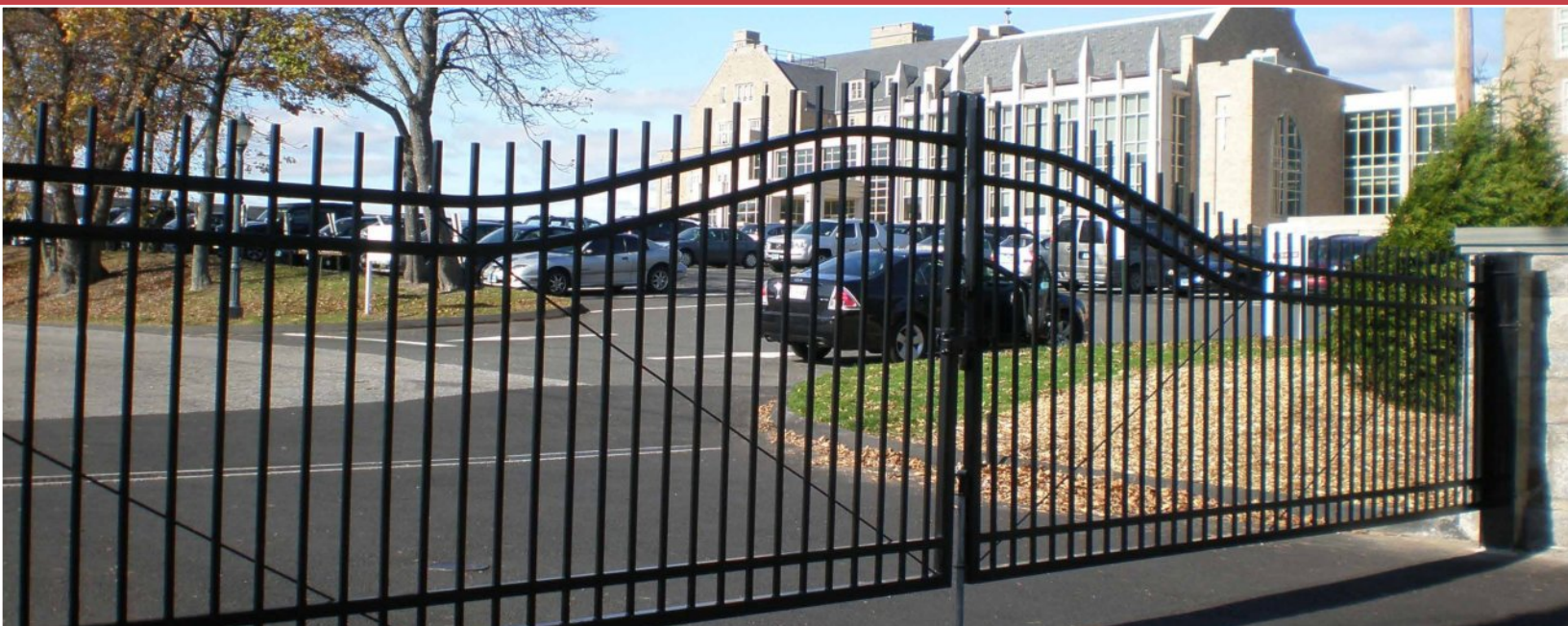

FLAT TOP WALK GATES



FLAT TOP DRIVE GATES

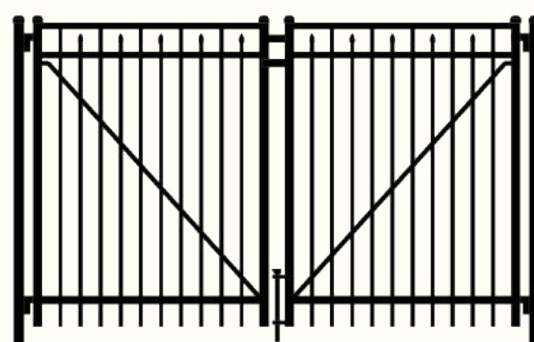

ARCHED TOP WALK GATES



ARCHED TOP DRIVE GATES

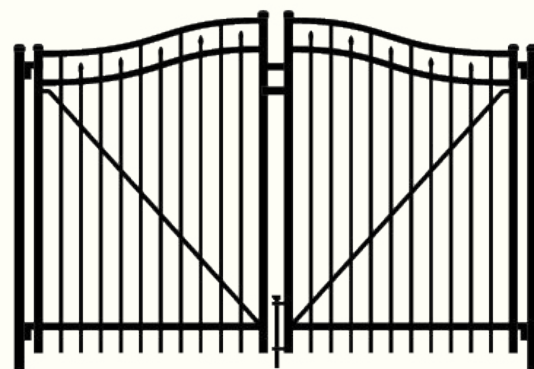

Slide Gates

Iron World Fencing prides itself on producing the BEST slide gates in the industry. With our Golden Gate Series, you get the most up-to-date construction features backed by Iron World's quality reputation for craftsmanship, competitive pricing, short lead times and reasonable shipping. Slide Gates are available in aluminum chain link slider or ornamental powder coated slider. Features include a closed track system with lubricated eight bearing rollers to protect from the elements and guarantee smooth opening and closing.

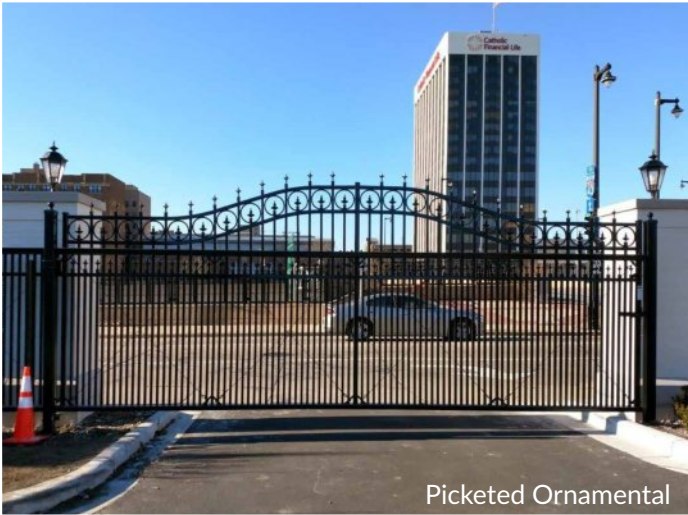

Picketed Ornamental



Aluminum Slide Gates



Aluminum Chain Link



Custom Design & Colors

SPECIFICATIONS

- Available in aluminum chain link slider or ornamental powder coated slider
- Features closed track system with lubricated eight bearing rollers to protect from the elements and guarantee smooth opening and closing
- Made from T-6063 aluminum and wired in aluminized fabric or picketed for ornamental projects
- Custom made to fit your needs: arches, rings, finials, etc.
- Made with safety in mind – Automated gate package which meets UL 325 compliance available
- Comes with welded gussets and 1/4 air craft cables for easy adjustment to guarantee smooth operation

SLIDE GATE FEATURES

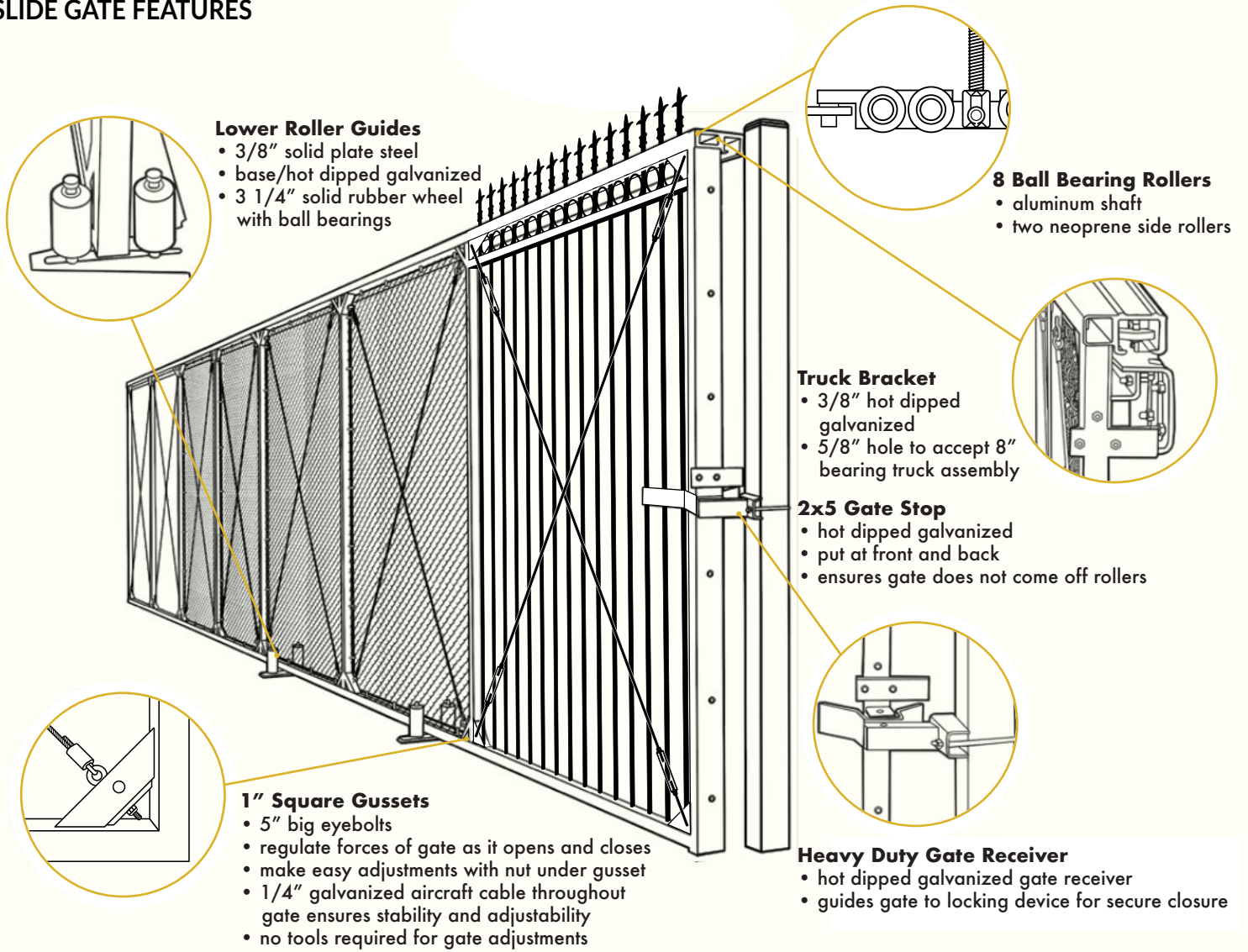



Panel and Gate Hardware



Latch



Hinges



Magnetic Pool
latch



Aluminum Drop Rod



Flat Bracket



Swivel Bracket

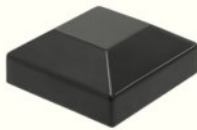

Post Cap



Picket Plug



Fleur de Lis



Triad



Ball



Rings

Prestigic Fence Products

Like many of you, we started our fence journey when a family member- Dad, Mother, Brother, or Sister- put a fence tool in our hands and told us to go help. The fence industry has been built on generations of families building a business based on the community's and families' needs. The same is true about us at Prestigic Vinyl Creations. Dan Wilson started his journey in the fence industry with his dad while living in the great state of Michigan. As just a young boy, his dad put him to work helping where needed, not knowing he was equipping Dan with a lifelong profession; one that he would use and develop from the early days as a helper to an installer and then to owning his own fence company in Middle Tennessee in 1983. Dan and his wife Teresa saw the need for a new fence product category, PVC Vinyl. In 2000 Tennessee needed someone to fabricate PVC profile materials into finished goods so they equipped themselves to serve the fence industry as specialists in this category and haven't looked back. They began with the thought, "If you can draw it, we can build it" and have now been serving the fence industry for 36 years.



We at PVCFP have been blessed to grow our service area to the Mid-South region of the US over the years. We've grown from a small fence guy in Michigan to a trusted fence supplier now in Centre, Alabama for the many great people we call our customers. Please let us help you grow your business, one fence job at a time. We stock standard to custom PVC vinyl

fencing in many colors and standard residential Aluminum in black.



Prestigic Fence Products

☎ 866-697-8237

✉ info.pvcfp.com

🌐 www.pvcfp.com



Specifications

Components	Maverick Ultra	Maverick Ultra Plus	Maverick Ultra II
Pickets (Size and Wall Thickness)	5/8sq x .045	3/4sq x .050	1"sq x .062
Rails: Side Walls	1.00" x 1.00" Triple .080	1.50" x 1.20" Triple .080	1-5/8" x 1-5/8" Triple .100
Pickets 6' Wide Sections	15	14	13
Pickets 8' Wide Sections	N/A	19	18
Post Standards	2" x 2" x .062 2" x 2" x .080	2" x 2" x .080 2 1/2" x 2 1/2" x .080 2 1/2" x 2 1/2" x .125 3" x 3" x .125	2 1/2" x 2 1/2" x .080 2 1/2" x 2 1/2" x .125 3" x 3" x .125
Post Gate	2" x 2" x .125 2 1/2" x 2 1/2" x .125 3" x 3" x .125 4" x 4" x .125	2" x 2" x .125 2 1/2" x 2 1/2" x .125 3" x 3" x .125 4" x 4" x .125	2 1/2" x 2 1/2" x .125 3" x 3" x .125 4" x 4" x .125
Picket Spacing	<4" TYP.	<4" TYP.	<4" TYP.
Standard Heights	36", 42", 48", 54", 60", 72"	36", 42", 48", 54", 60", 72"	36", 42", 48", 54", 60", 72", 84", 96"
Alloy	6063/T5 alloy on pickets, posts, and rails. 6005/T5 alloy available on posts.	6063/T5 alloy on pickets, posts, and rails. 6005/T5 alloy available on posts.	6063/T5 alloy on pickets, posts, and rails. 6005/T5 alloy available on posts.



IRON SHIELD

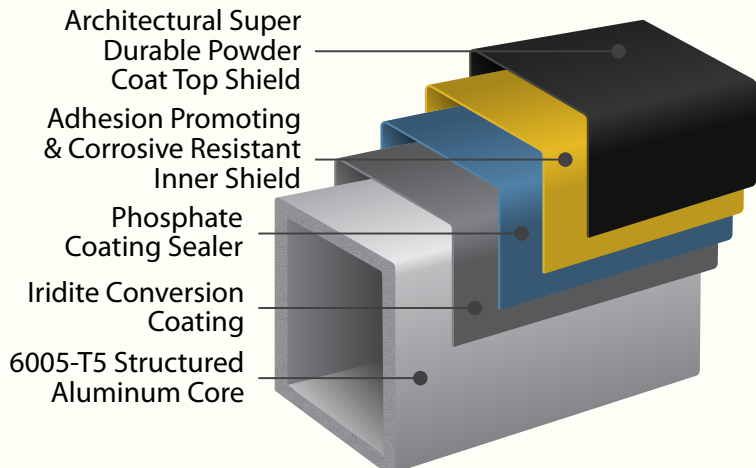

Process



Manufacturer powder coats all pickets, channels and posts loose rather than assembled to ensure 100 percent powder coating coverage of all parts.



We package all panels, posts, and gates on skids with vinyl clips in between each panel to ensure no scratching. Then we wrap and heat shrink it to ensure your product gets to you damage free.

Lifetime Limited Warranty

Iron World Mfg. warrants to the original owner that all of our products will be free of manufacturing and material defects. Our powder coating finish on our aluminum fences will not peel, crack, chip, or blister for as long as you own the fence.

This warranty does not cover damages caused by improper use, application, or installation; abuse; alterations; negligence; vandalism; or acts of God. The warranty also does not extend to the normal weathering, slight discoloration, or chalking caused by prolonged exposure to the elements, mildew, or air pollution. There is no other express warranty except that stated herein.

This lifetime warranty is intended to cover original owners only and is not transferable. The original owner is covered by the warranty for as long as he owns and resides in the property on which the product was first installed. In the event of commercial or otherwise non-residential use, Iron World limits this product warranty to 20 years with a starting date of the original day of installation.

In case of a warranty claim, the owner must provide Iron World a written notice specifying the nature of the defect, along with proof of purchase, within 20 days of the failure. Iron World reserves the right to inspect the material in question to determine the validity of the claim. Defective material must be shipped to Iron World's facility for inspection freight pre-paid. If the product fails to conform to this warranty, Iron World will replace or repair the defective material at its discretion. Iron World shall not be liable or responsible for labor charges or other expenses whatsoever in connection with removal or installation of either the original or replacement product.

The above constitutes the complete limited lifetime warranty by Iron World and no other agreement, written or implied, is valid. No person is authorized to change or modify this warranty. Recoveries for consequential or incidental damages are hereby excluded.

Iron World Management



Manufacturer Family of Products

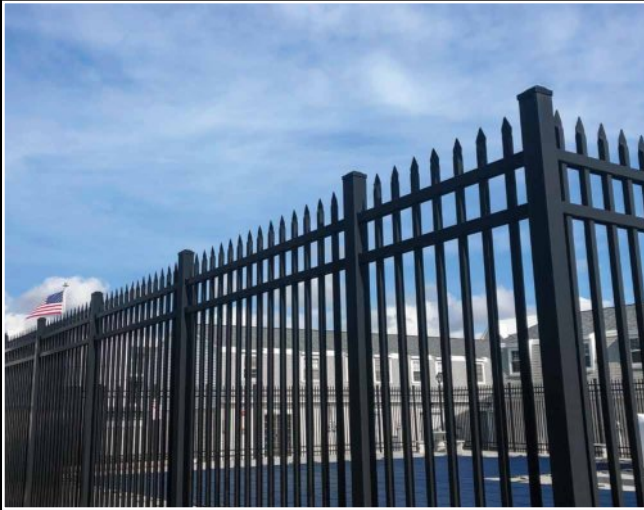

MAVERICK ULTRA™
RESIDENTIAL, COMMERCIAL,
AND INDUSTRIAL ALUMINUM



MAVERICK™ SUPREME
RESIDENTIAL AND COMMERCIAL STEEL



MAVERICK™
ORNAMENTAL IRON



GOLDEN GATE™
CHAIN LINK & ORNAMENTAL SLIDE GATES



Prestigic Fence Products
YOUR FENCE PROFESSIONALS
"Exceptional Service is our signature."



Product



Contact

Last Updated 7/27/2023

